

IN-043

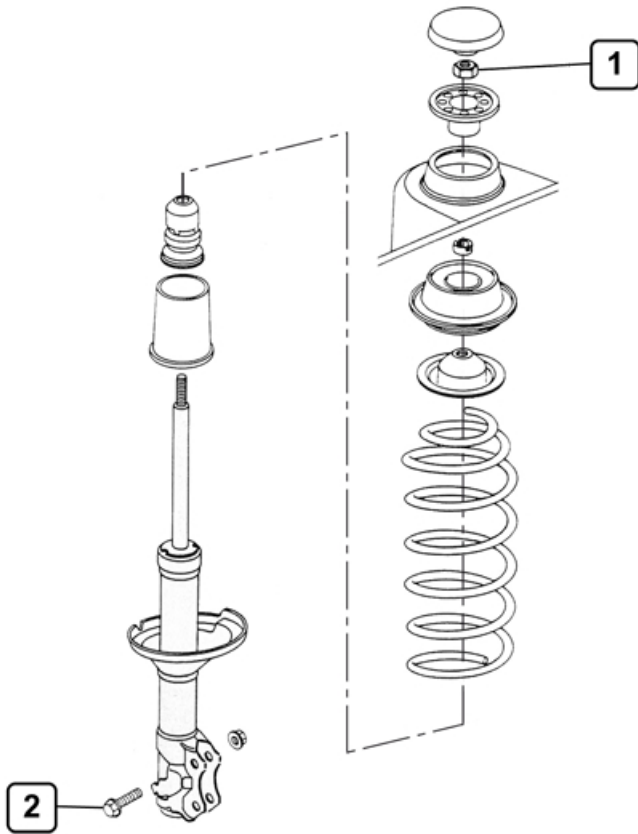

- 1** 60 Nm
- 2** 80 Nm



O.E
KYB

