

IN-013

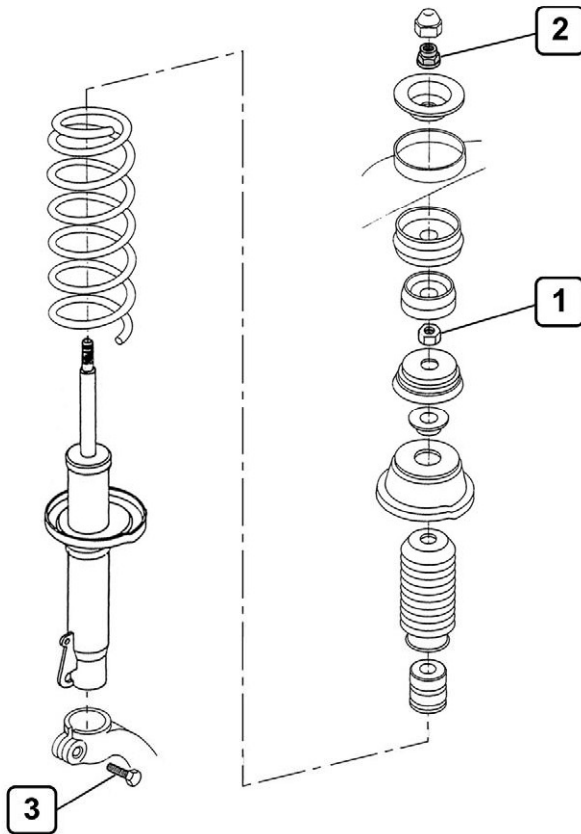

- 1** 46 Nm
- 2** 22 Nm
- 3** 75 Nm



 O.E.
 KYB

